

# BMW C-EVOLUTION '16 -

## M O U N T I N G I N S T R U C T I O N S

REF 1769

**WINDSHIELD V-TECH LINE TOURING  
(WINDSCREEN INCLUDES DETACHABLE HAND DEFLECTORS)**











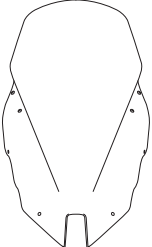

**OPTION A**  
WINDSHIELD  
WITHOUT  
HAND-DEFLECTORS



**OPTION B**  
WINDSHIELD  
WITH  
HAND-DEFLECTORS



ID	PIEZA/PART	DESCRIPCIÓN	DESCRIPTION	QTY	REF
1		Cúpula touring	Touring screen	1	1769H/WM3
2		Deflector izquierdo	Left deflector	1	1769H/W-IZD
3		Deflector derecho	Right deflector	1	1769H/W-DER
4		Silentblock Ø17 x Ø10 x Ø13 x 10	Ø17 x Ø10 x Ø13 x 10 silentblock	4	AROPASACABLES--
5		Casquillo con valona M5 (negro)	M5 bush with flange (black)	4	CASQUI-----517
6		Tornillo Allen M5x11 Ø11 ISO 7380	M5x11 Ø11 ISO 7380 Allen screw	4	TORNI-AI----520
7		Tornillo Allen M5x16 Ø11 ISO 7380	Allen screw M5x16 Ø11 ISO 7380	4	TORNI-I7380-493
8		Arandela nylon M5x1	M5x1 nylon washer	4	ARNV0000000245
9		Tapón tornillo M5 ISO 7380	M5 ISO 7380 screw cap	4	TAPON-----85
10		Velcro dual lock 25x30mm (se suministra montado con pieza ID2/ID3)	25x30mm dual lock Velcro (supplied already mounted on items 2/3)	2	VELCRO-25X50---
11		Set adhesivos (se suministra montado con pieza ID2/ID3)	Sticker set (supplied already mounted on items 2/3)	1	ADHESI-----260

# BMW C-EVOLUTION '16 -

INSTRUCCIONES DE MONTAJE - MOUNTING INSTRUCTIONS - MONTAGEANLEITUNG

**1**

DISASSEMBLY  
DESMONTAJE

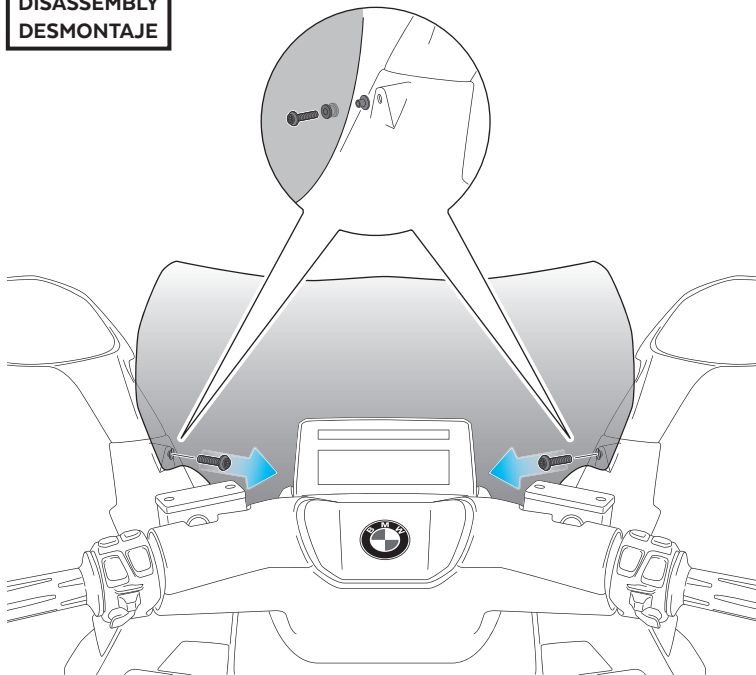

**2**

DISASSEMBLY  
DESMONTAJE

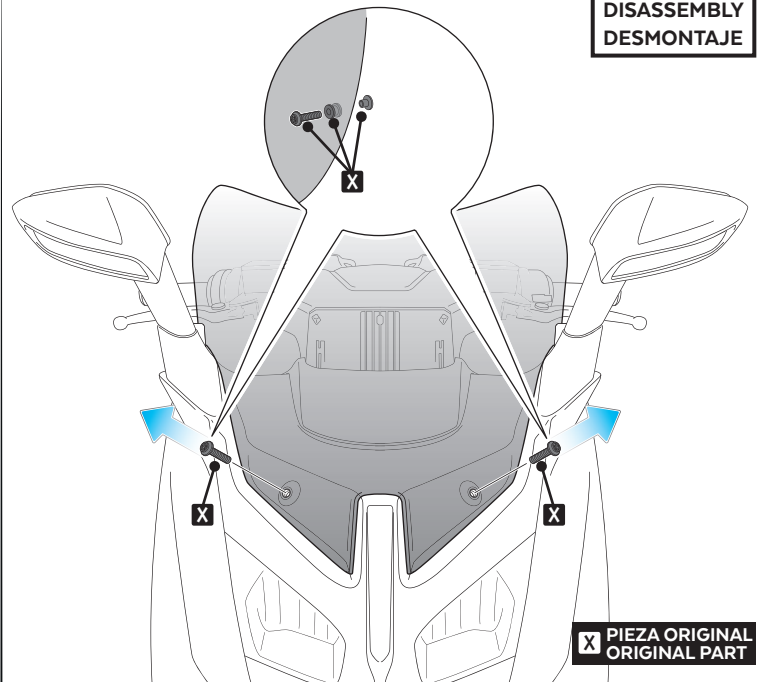

PIEZA ORIGINAL  
ORIGINAL PART

**3**

ASSEMBLY  
MONTAJE

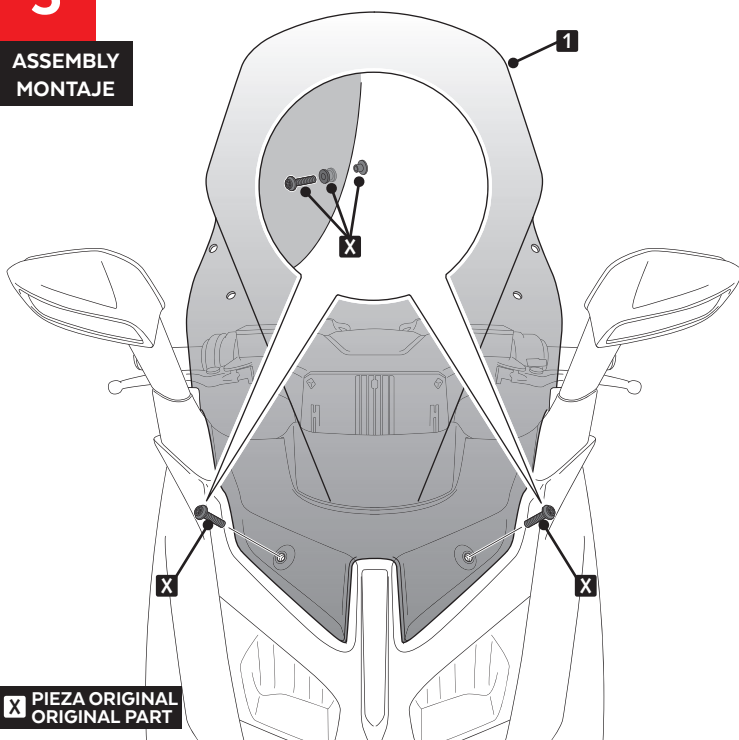

PIEZA ORIGINAL  
ORIGINAL PART

**4**

ASSEMBLY  
MONTAJE

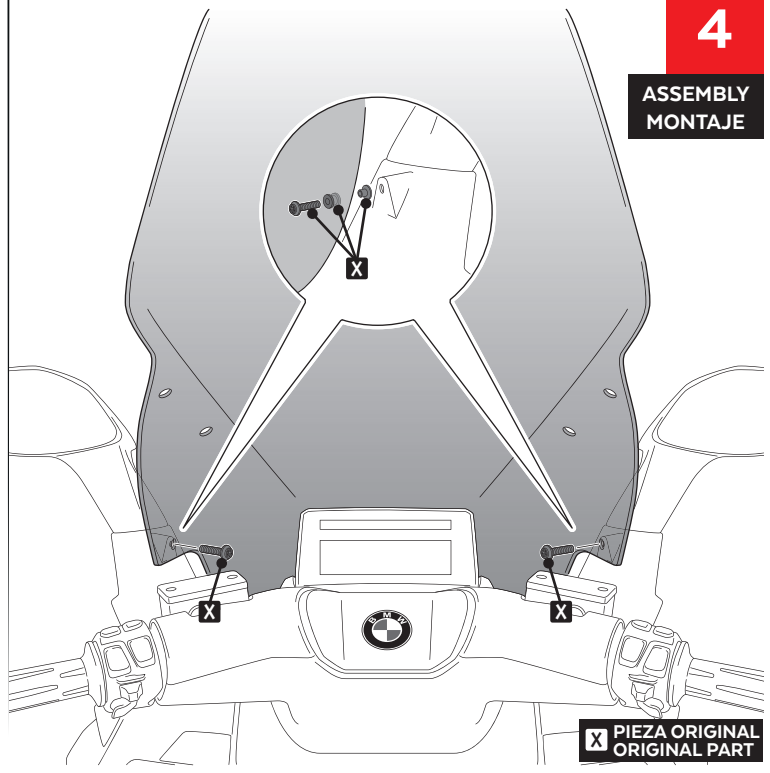

PIEZA ORIGINAL  
ORIGINAL PART

# BMW C-EVOLUTION '16 -

INSTRUCCIONES DE MONTAJE - MOUNTING INSTRUCTIONS - MONTAGEANLEITUNG

## OPTION A

WINDSHIELD  
WITHOUT  
HAND-DEFLECTORS

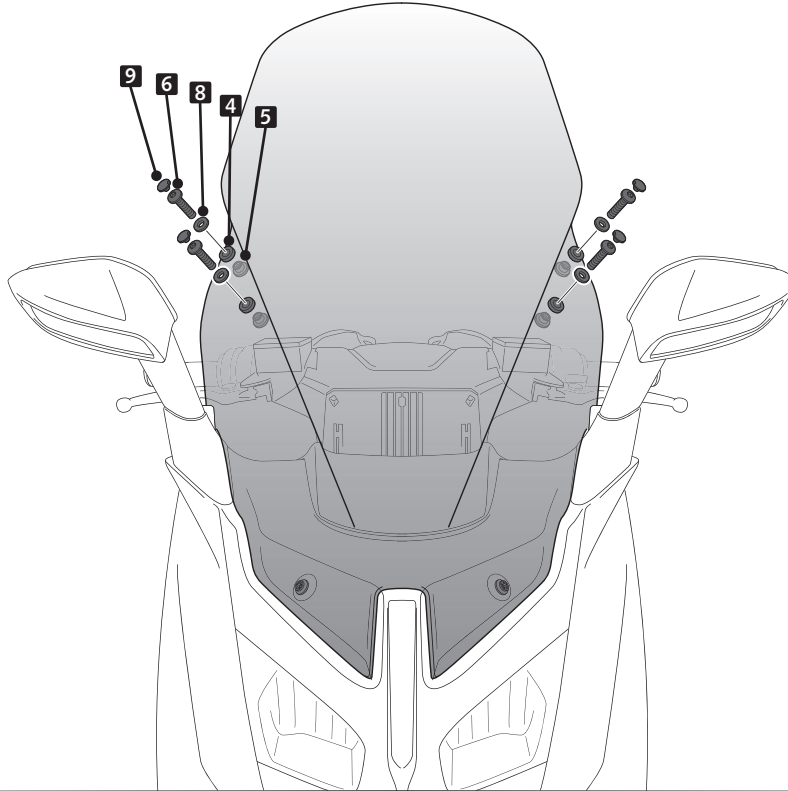

## OPTION B

WINDSHIELD  
WITH  
HAND-DEFLECTORS

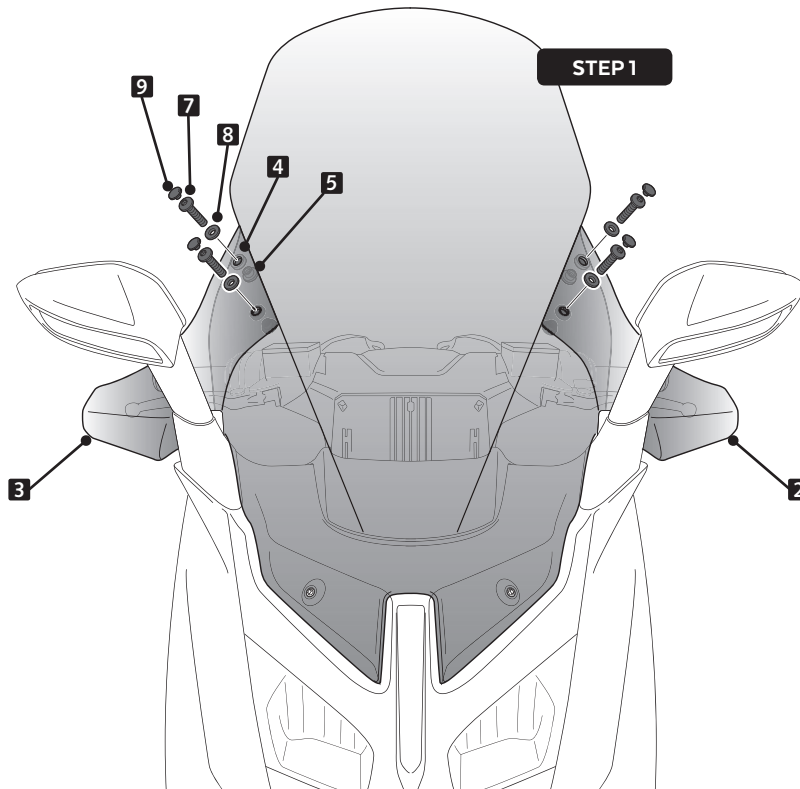

## STEP 2

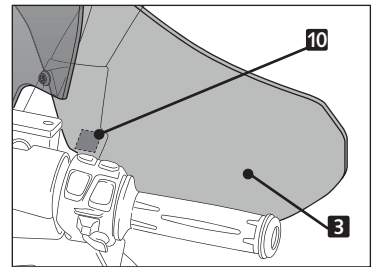

Nota: Extraer papel del adhesivo del velcro (ID 10- se suministra montado en las piezas ID2/3) y posicionar en el retrovisor.

Extract the paper from the velcro (ID-10 supplied already mounted on items ID2/3) and position to rearview.

